

VENTANA CORREDIZA

V.C. 0201

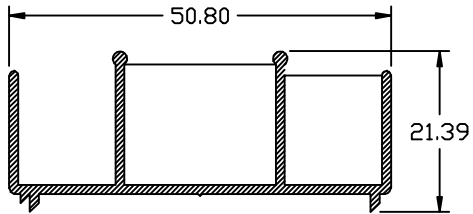

FISA-511

RIEL SUPERIOR MARCO

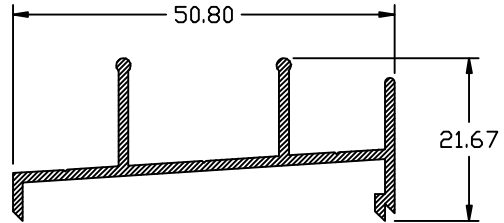

FISA-513

RIEL INFERIOR

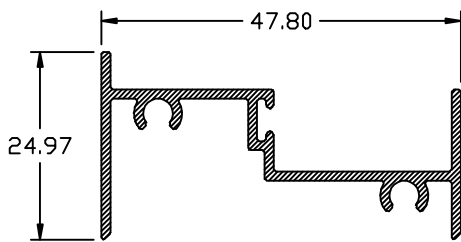

FISA-512

JAMBA MARCO

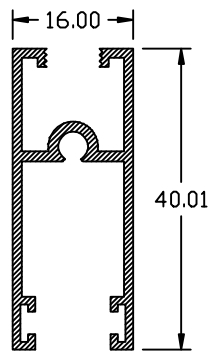

FISA-297

HORIZONTAL

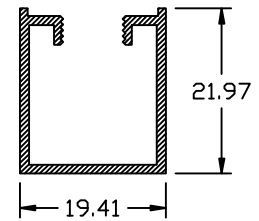

FISA-719

VERTICAL

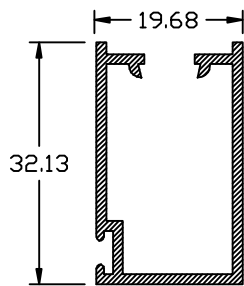

FISA-510

VERTICAL ABIERTO

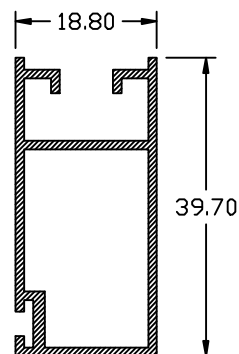

FISA-614

VERTICAL HOJA CERRADA

VENTANA CORREDIZA V.C. 0201

CORTE VERTICAL

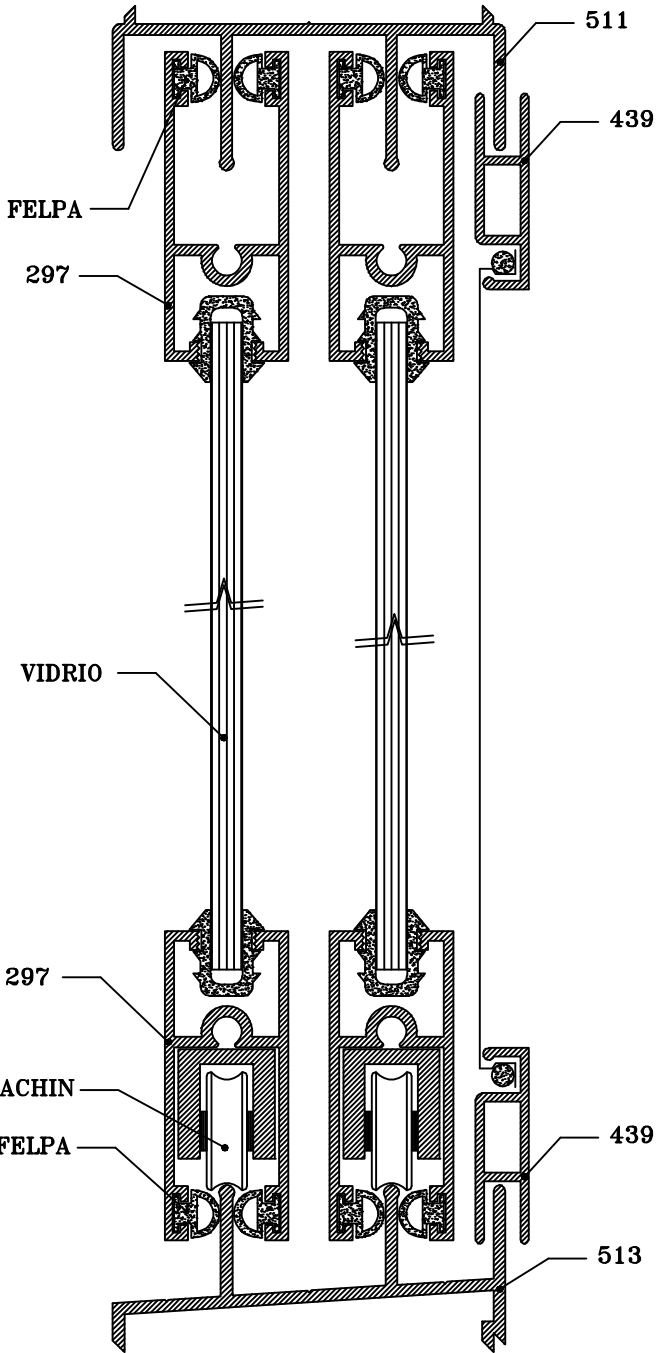

CORTE HORIZONTAL

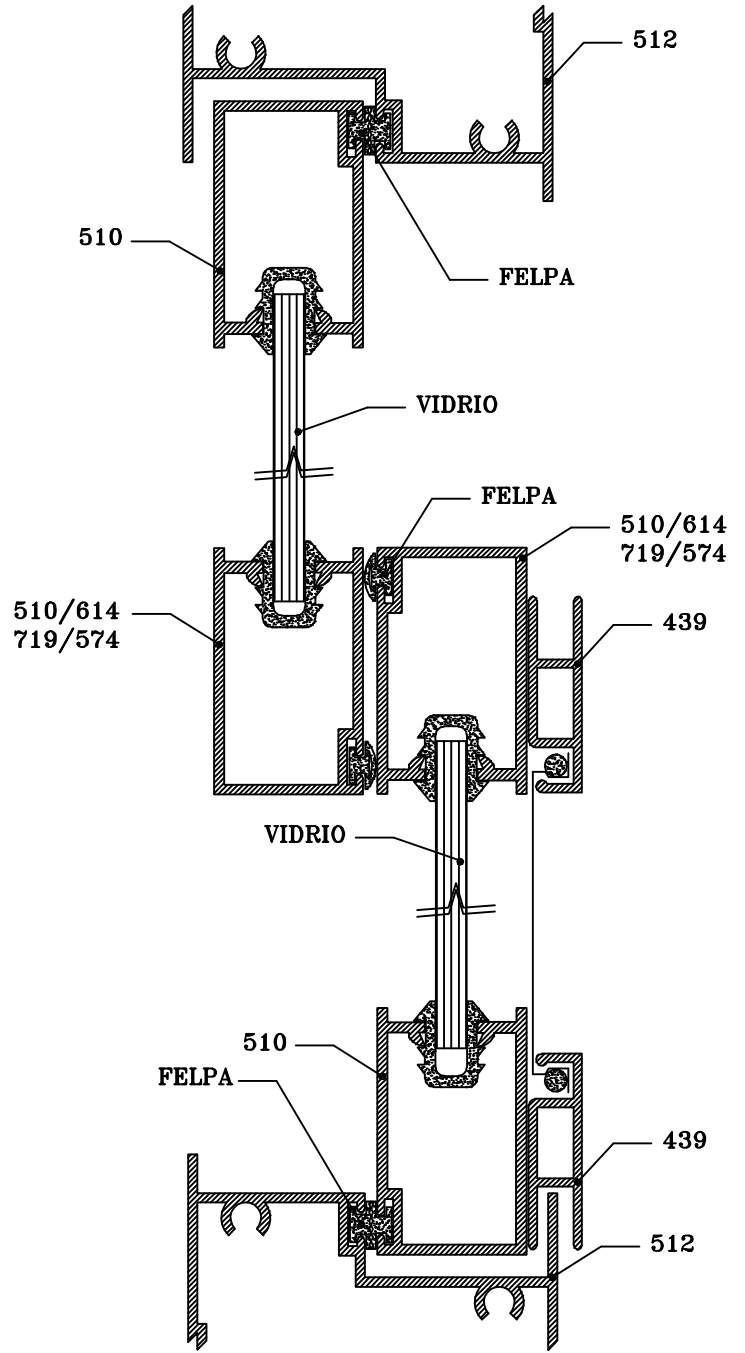

UBICACION LOGICA	PERFIL REF.
RIEL SUPERIOR MARCO	511
RIEL INFERIOR	513
JAMBA MARCO	512
HOJA HORIZONTAL	297
HOJA VERTICAL	510/614/719/574
PERFIL MALLA	439

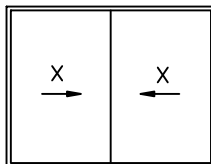

ESCALA: 1:1

#4