

VENTANA CORREDIZA

V.C. 0202

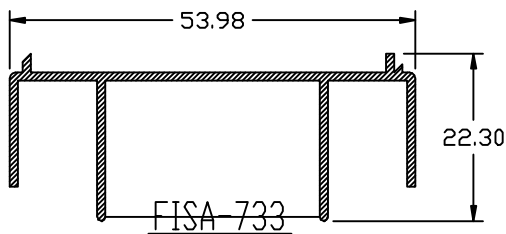

RIEL SUPERIOR

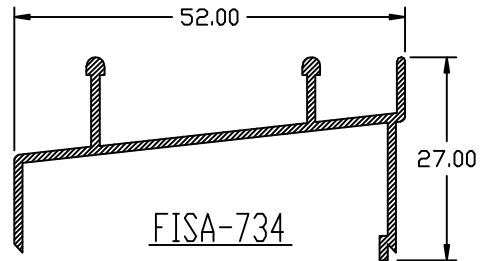

RIEL INFERIOR

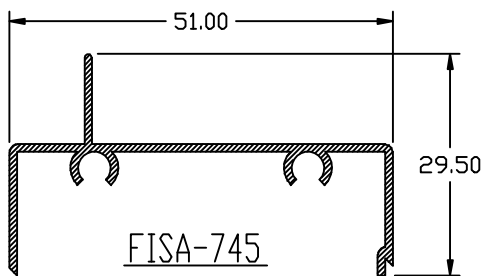

JAMBA MARCO

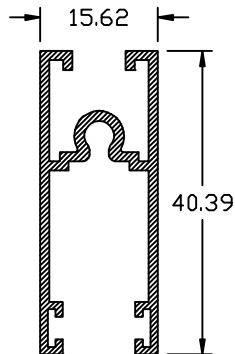

FISA-1993

HORIZONTAL
PESADO

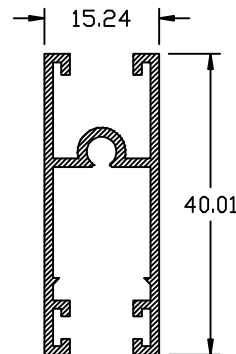

FISA-742

HORIZONTAL

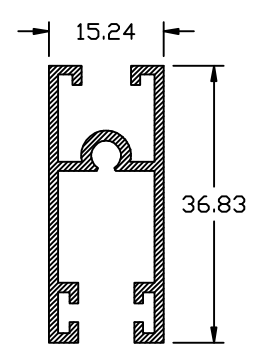

FISA-974

HORIZONTAL

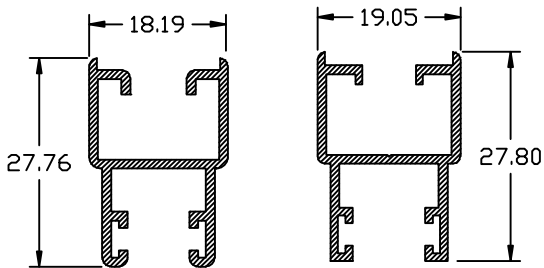

FISA-741

VERTICAL

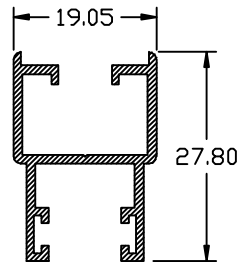

FISA-1994

VERTICAL

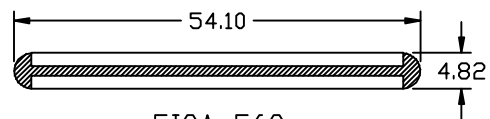

FISA-562

MULLO

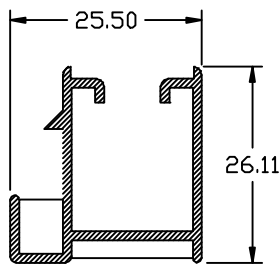

FISA-744

ENTRECIERRE
FIJO

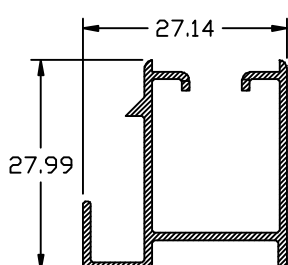

FISA-1995

ENTRECIERRE
FIJO

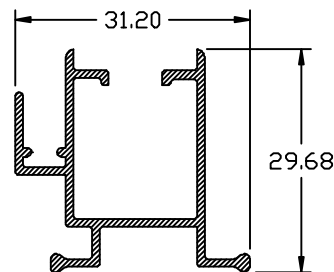

FISA-1996

ENTRECIERRE
HOJA

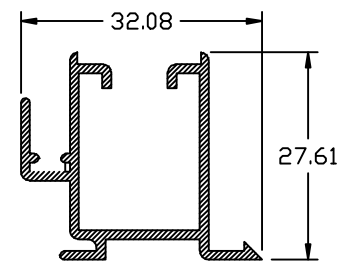

FISA-743

ENTRECIERRE
HOJA PESADO

VENTANA CORREDIZA V.C. 0202

CORTE VERTICAL

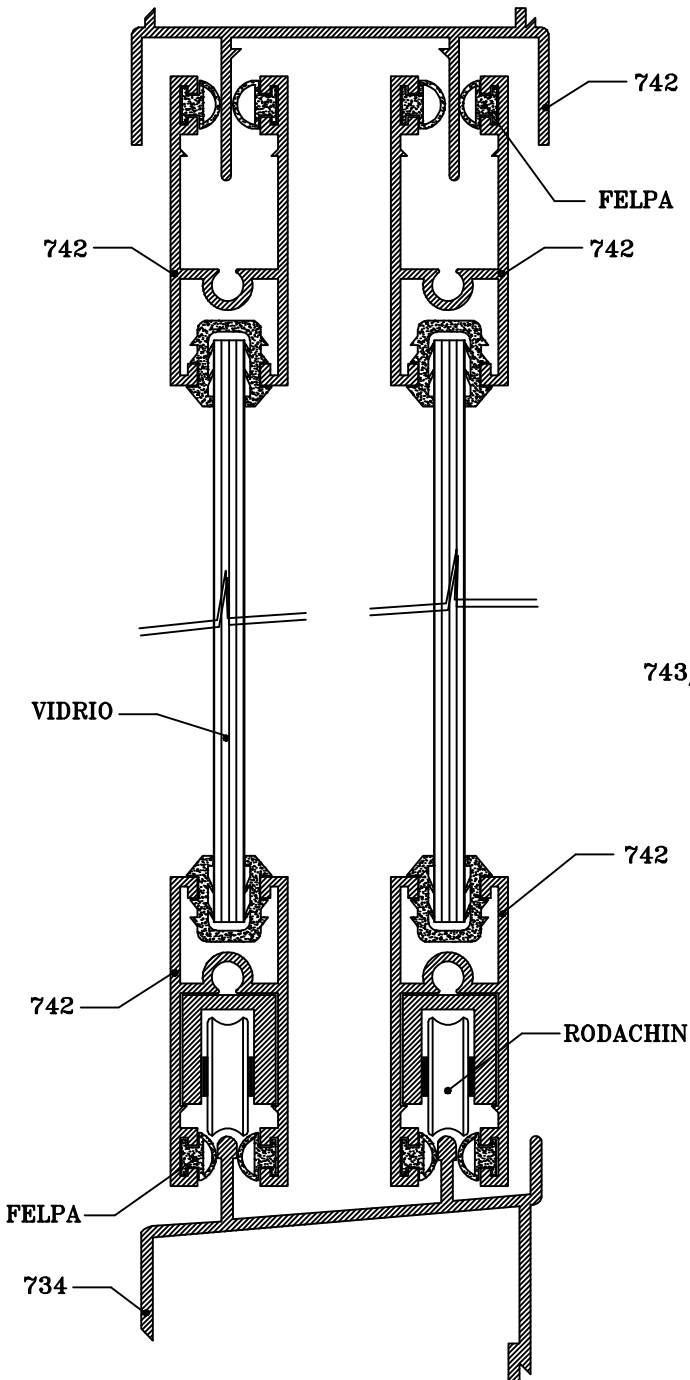

CORTE HORIZONTAL

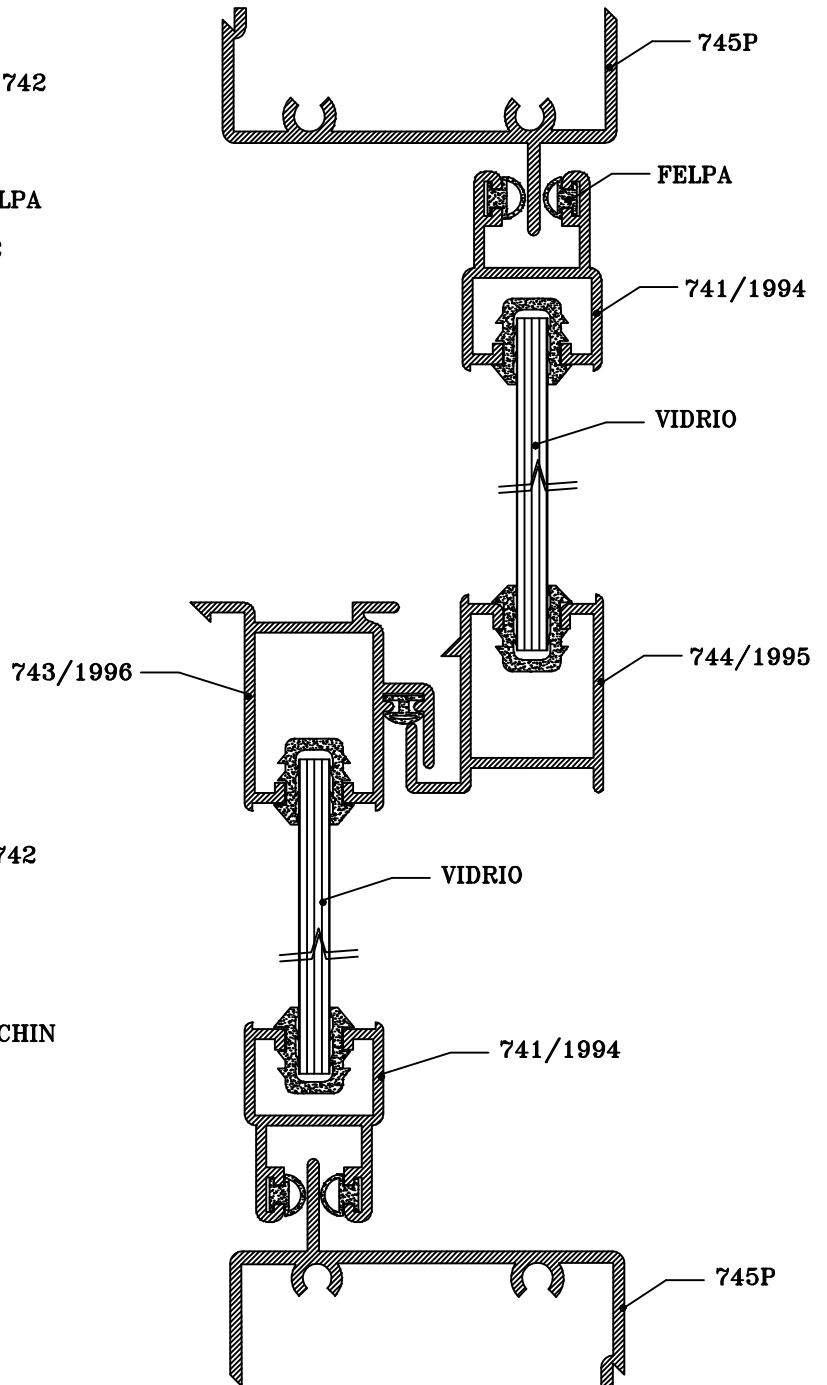

UBICACION LOGICA	PERFIL REF.
RIEL SUPERIOR	733
RIEL INFERIOR	734
JAMBA MARCO	745P
HOJA HORIZONTAL	742/1993
HOJA VERTICAL	741/1994
ENTRECIERRE HOJA	743/1996
ENTRECIERRE FIJO	744/1995

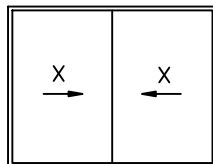

ESCALA:
1:1

#5